

-006

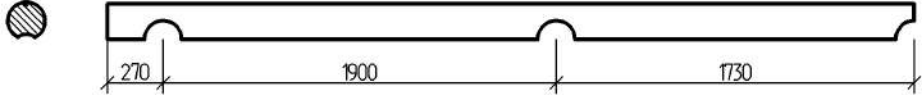
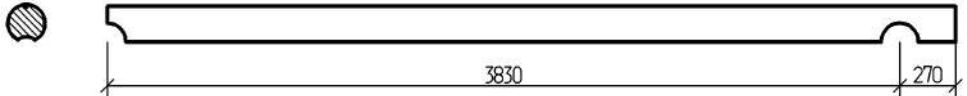
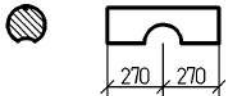
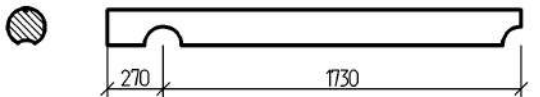
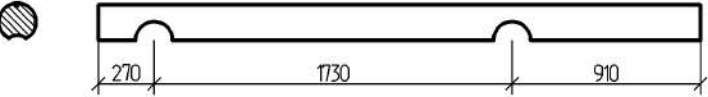
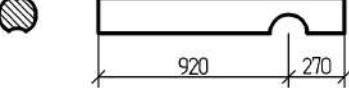
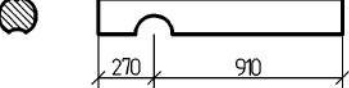
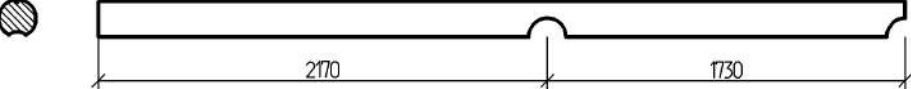
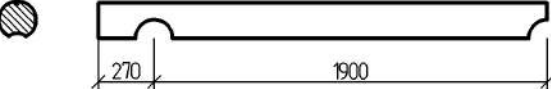
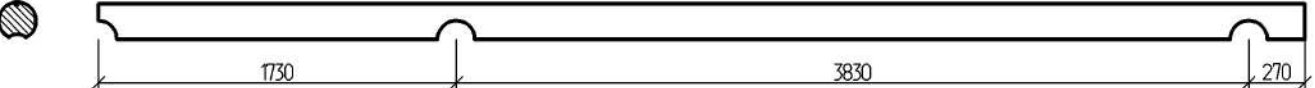
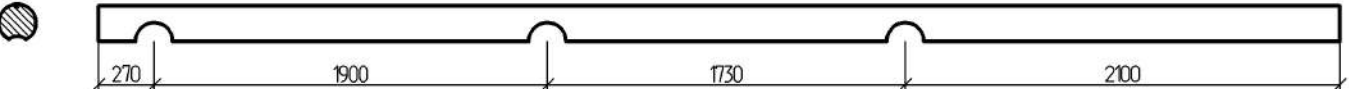
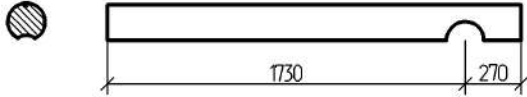
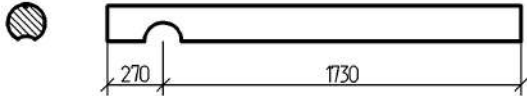
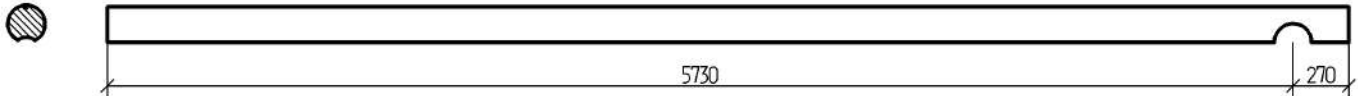
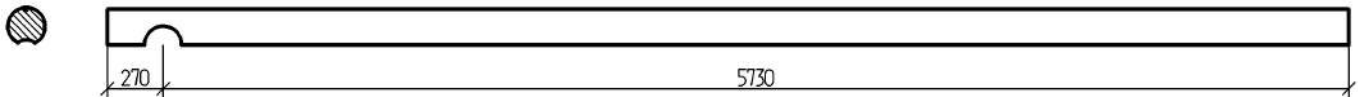
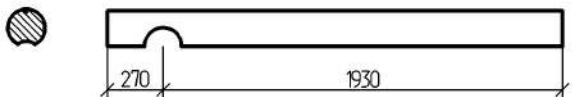
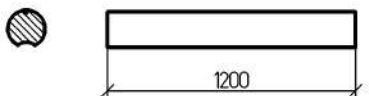
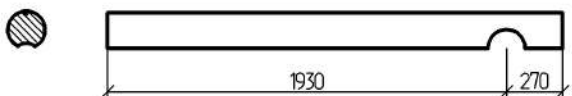

27.06.2021 6:59:54

1. : 180, .			
			- (): 100 (): 222,86 (.): 5,67
1_1_1, 1_19_1	3900	2	
1_1_2, 1_2_3, 1_3_3, 1_4_3, 1_5_3, 1_6_3, 1_12_2, 1_17_2, 1_19_2	4100	9	
1_2_1, 1_3_1, 1_4_1, 1_5_1, 1_6_1, 1_13_1, 1_14_1, 1_15_1, 1_16_1	540	9	
1_2_2, 1_3_2, 1_4_2, 1_5_2, 1_6_2, 1_12_1	2000	6	

<p>1_7_1, 1_8_1, 1_9_1, 1_10_1, 1_11_1</p>	<p>2910</p>	<p>5</p>	
<p>1_7_2, 1_8_2, 1_9_2, 1_10_2, 1_11_2, 1_13_3, 1_14_3, 1_15_3, 1_16_3</p>	<p>1190</p>	<p>9</p>	
<p>1_13_2, 1_14_2, 1_15_2, 1_16_2</p>	<p>1180</p>	<p>4</p>	
<p>1_17_1</p>	<p>3900</p>	<p>1</p>	
<p>1_18_1</p>	<p>2170</p>	<p>1</p>	
<p>1_18_2</p>	<p>5830</p>	<p>1</p>	
<p>1_20_1</p>	<p>6000</p>	<p>1</p>	

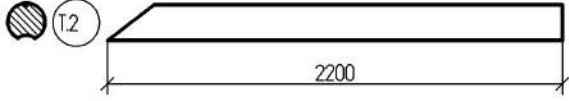
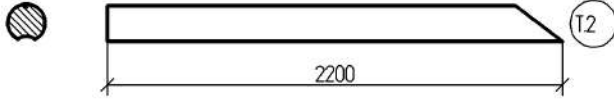
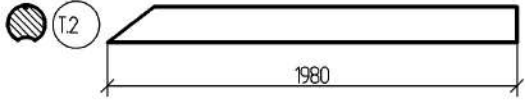
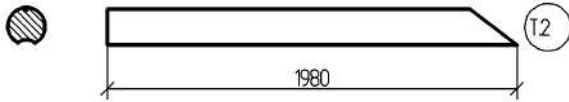
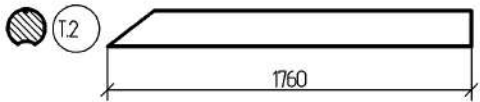
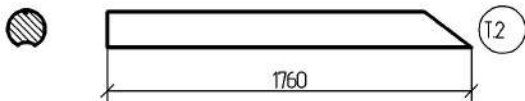
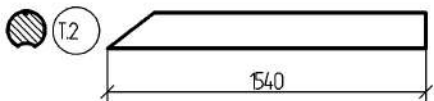
1_20_2, 1_22_2, 1_24_2, 1_26_2	2000	4	
1_21_1, 1_23_1, 1_25_1	2000	3	
1_21_2, 1_23_2, 1_25_2	6000	3	
1_22_1, 1_24_1, 1_26_1	6000	3	
1_27_1	2200	1	
1_27_2, 1_28_2, 1_29_2, 1_30_2, 1_31_2, 1_32_2, 1_33_2, 1_34_2, 1_35_2, 1_36_2	1200	10	
1_27_3	2200	1	

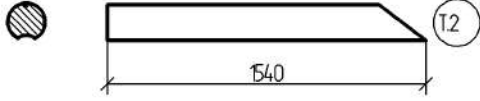
1_28_1	2200	1	
1_28_3	2200	1	
1_29_1	1980	1	
1_29_3	1980	1	
1_30_1	1760	1	
1_30_3	1760	1	
1_31_1	1540	1	

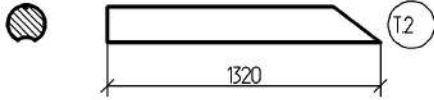
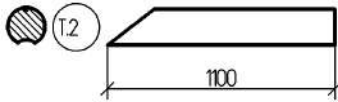
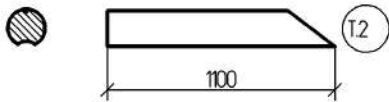
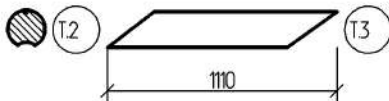
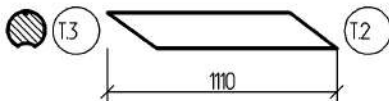
1_31_3	1540	1	
1_32_1	1320	1	
1_32_3	1320	1	
1_33_1	1100	1	
1_33_3	1100	1	
1_34_1	1110	1	
1_34_3	1110	1	

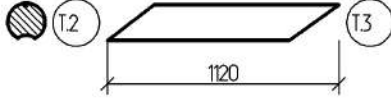
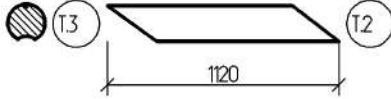
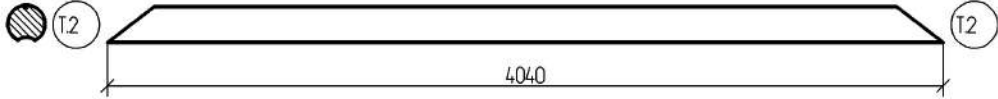
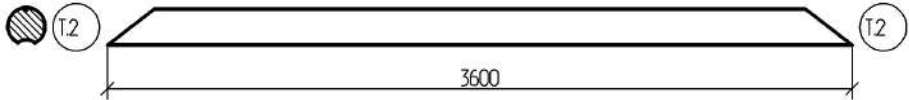
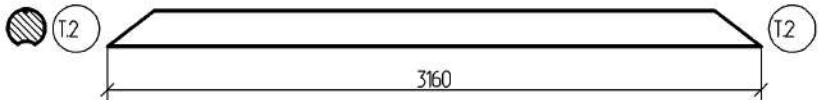
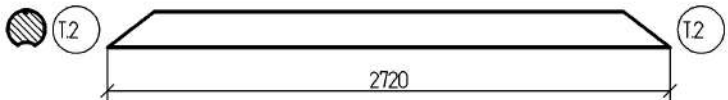
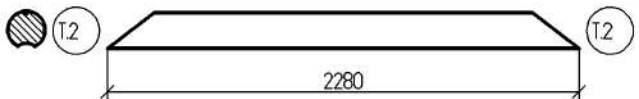
1_35_1, 1_36_1	1120	2	
1_35_3, 1_36_3	1120	2	
1_37_1	4040	1	
1_38_1	3600	1	
1_39_1	3160	1	
1_40_1	2720	1	
1_41_1	2280	1	

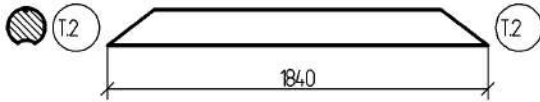
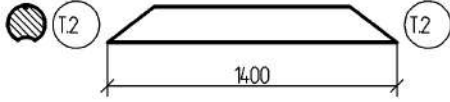
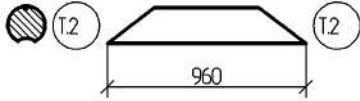
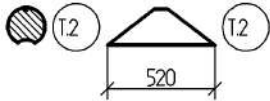
1_42_1	1840	1	
1_43_1	1400	1	
1_44_1	960	1	
1_45_1	520	1	

180, .	1.	:	222,86 . .	5,67 . .	100 .		35,66 . .
			0,00 . .	0,00 . .	0 .		129,93 . .

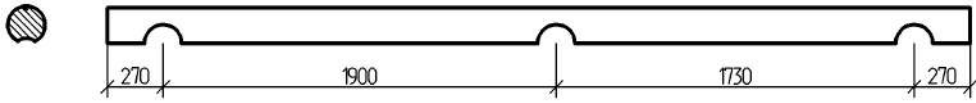
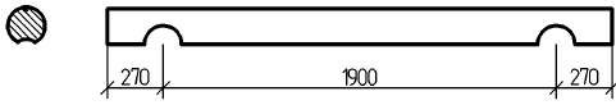
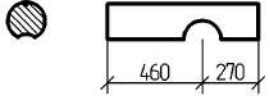
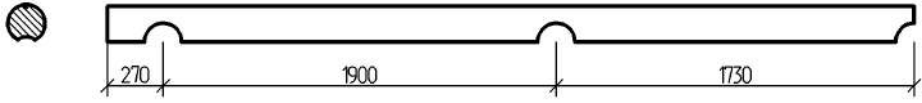
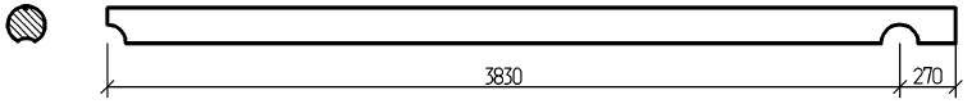
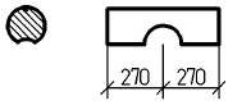
				2.	:	180,	.		
								- ():	40
								():	79,01
								(.):	2,01
2_1_1, 2_8_1, 2_15_1, 2_16_1, 2_17_1, 2_18_1, 2_19_1	4170	7							
2_2_1, 2_3_1, 2_4_1, 2_5_1, 2_6_1, 2_7_1, 2_9_1, 2_10_1, 2_11_1, 2_12_1, 2_13_1, 2_14_1	2440	12							
2_2_2, 2_3_2, 2_4_2, 2_5_2, 2_6_2, 2_7_2, 2_9_2, 2_10_2, 2_11_2, 2_12_2, 2_13_2, 2_14_2	730	12							
2_20_1	3900	1							
2_20_2	4100	1							
2_21_1, 2_22_1, 2_23_1, 2_24_1, 2_25_1, 2_26_1, 2_27_1	540	7							

180, : 2. .	:	79,01 . .	2,01 . .	40 .		12,64 . .
		0,00 . .	0,00 . .	0 .		46,61 . .

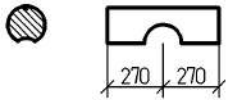
3. : 180, .						
						- (): 7 (): 3,78 (.): 0,10
3_21_1, 3_22_1, 3_23_1, 3_24_1, 3_25_1, 3_26_1, 3_27_1	540	7				
3. : 180,	:	3,78 . .	0,10 . .	7 .	:	0,60 . .
		0,00 . .	0,00 . .	0 .		2,46 . .

4. : 180, .			
			- (): 21 (): 91,03 (.): 2,32
4_1_1, 4_2_1, 4_3_1, 4_4_1, 4_5_1, 4_6_1, 4_7_1, 4_8_1, 4_9_1, 4_10_1, 4_11_1, 4_12_1, 4_13_1, 4_14_1, 4_15_1, 4_16_1, 4_17_1, 4_18_1, 4_19_1	4370	19	
4_20_1	3900	1	
4_20_2	4100	1	

180, .	4. :	91,03 . .	2,32 . .	21 .		14,56 . .
		0,00 . .	0,00 . .	0 .		52,63 . .

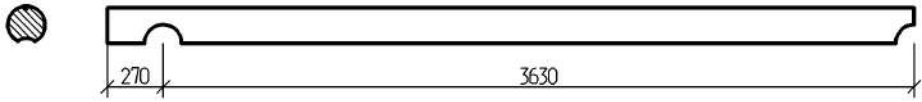
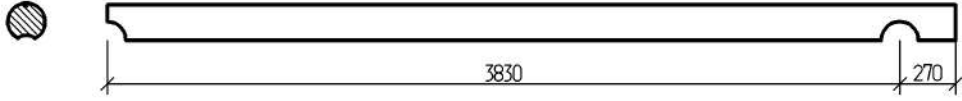
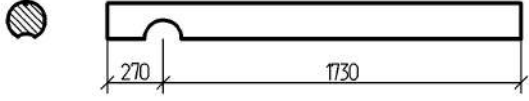
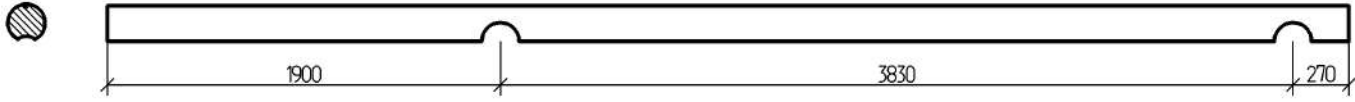
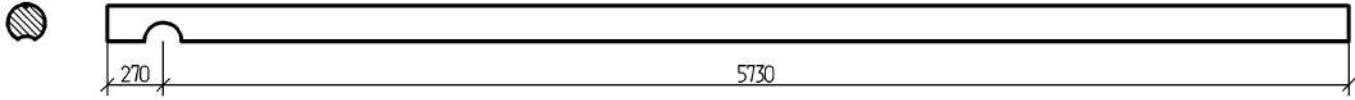
5. : 180, .				- (): 81
				(): 271,42
				(.): 6,91
5_1_1, 5_2_1, 5_3_1, 5_4_1, 5_5_1, 5_6_1, 5_7_1, 5_8_1, 5_9_1, 5_10_1, 5_11_1, 5_12_1, 5_13_1, 5_14_1, 5_15_1, 5_16_1, 5_17_1, 5_18_1, 5_19_1	3900	19		
5_1_2, 5_2_2, 5_3_2, 5_4_2, 5_5_2, 5_6_2, 5_7_2, 5_8_2, 5_9_2, 5_10_2, 5_11_2, 5_12_2, 5_13_2, 5_14_2, 5_15_2, 5_16_2, 5_17_2, 5_18_2, 5_19_2	4100	19		
5_20_1, 5_22_1, 5_24_1, 5_26_1	2000	4		
5_20_2	6000	1		
5_21_1, 5_23_1, 5_25_1	6000	3		

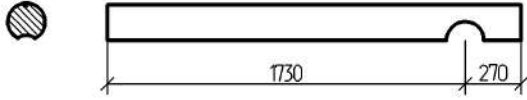
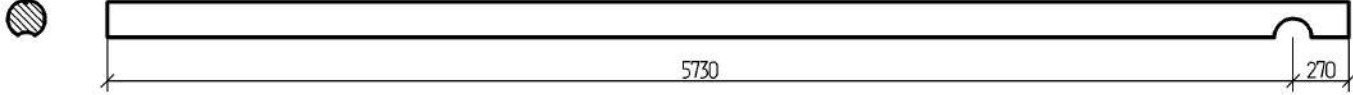
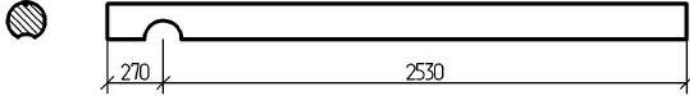
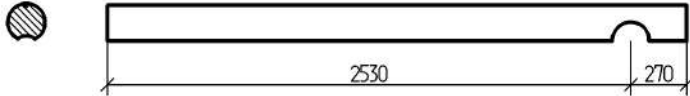
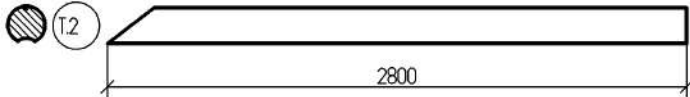
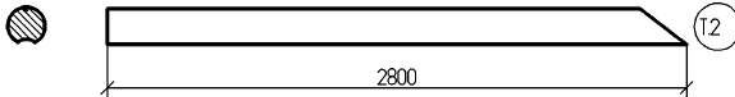
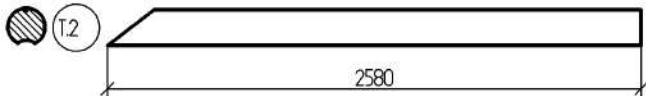
5_21_2, 5_23_2, 5_25_2	2000	3	
5_22_2, 5_24_2, 5_26_2	6000	3	
5_27_1	2800	1	
5_27_2	2800	1	
5_28_1	2800	1	
5_28_2	2800	1	
5_29_1	2580	1	

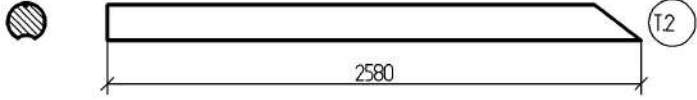
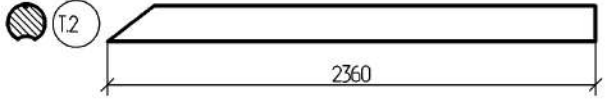
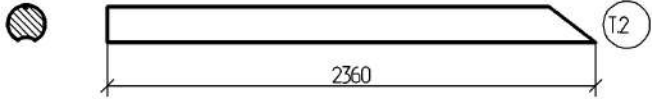
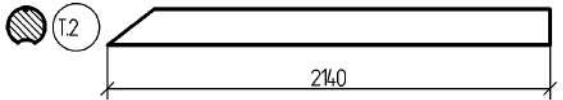
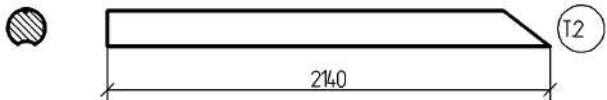
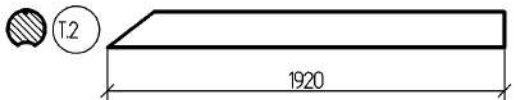
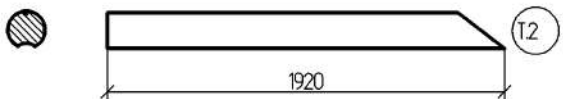
5_29_2	2580	1	
5_30_1	2360	1	
5_30_2	2360	1	
5_31_1	2140	1	
5_31_2	2140	1	
5_32_1	1920	1	
5_32_2	1920	1	

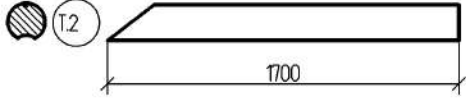
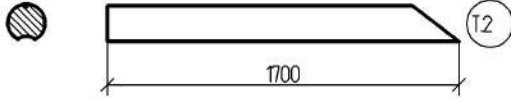
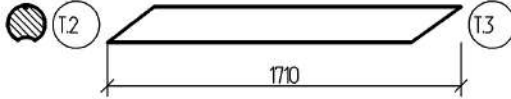
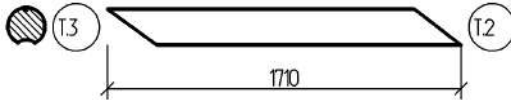
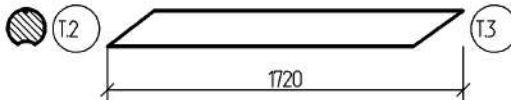
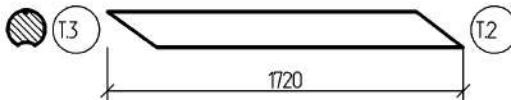
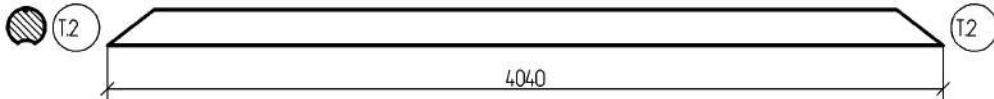
5_33_1	1700	1	
5_33_2	1700	1	
5_34_1	1710	1	
5_34_2	1710	1	
5_35_1, 5_36_1	1720	2	
5_35_2, 5_36_2	1720	2	
5_37_1	4040	1	

5_38_1	3600	1	
5_39_1	3160	1	
5_40_1	2720	1	
5_41_1	2280	1	
5_42_1	1840	1	
5_43_1	1400	1	
5_44_1	960	1	

5_45_1		520	1				
180,	:	5.	:	271,42 . .	6,91 . .	81 .	43,43 . .
				0,00 . .	0,00 . .	0 .	155,58 . .

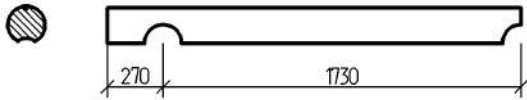
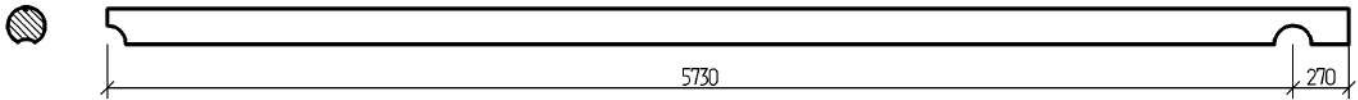
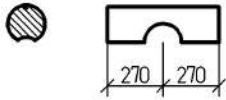
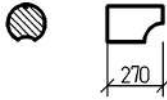
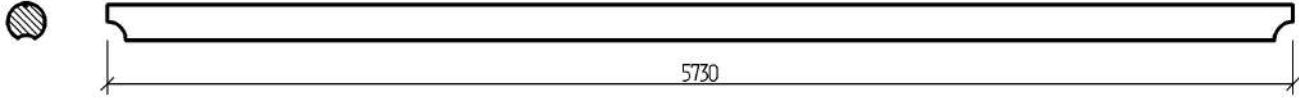
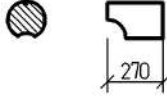
				. : 180, .	- (): 58 (): 170,73 (.): 4,34
_1_1, _2_1, _6_1, _17_1, _18_1, _19_1, _21_1, _22_1, _23_1, _24_1	2000	10			
_1_2, _2_2, _3_3, _6_2, _12_2, _17_2, _18_2, _19_2, _21_2, _22_2, _23_2, _24_2	6000	12			
_3_1, _4_1, _5_1	540	3			
_3_2, _4_2, _12_1	270	3			
_4_3	5730	1			
_4_4, _5_3	270	2			

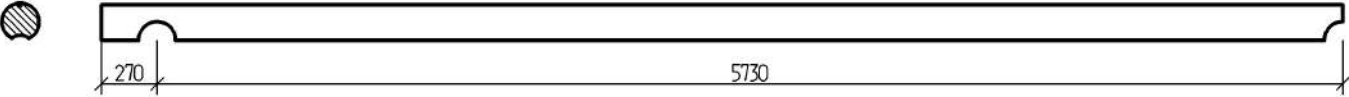
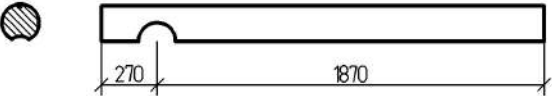
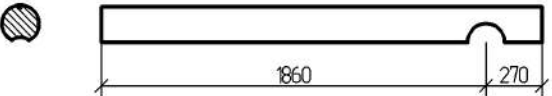
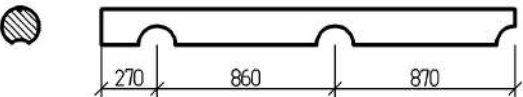
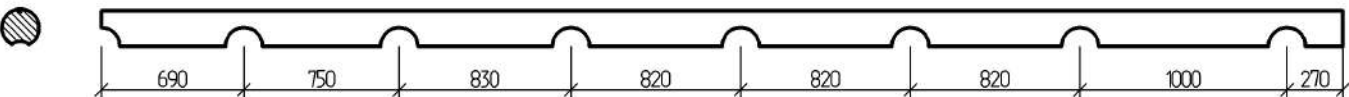
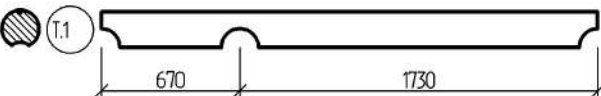
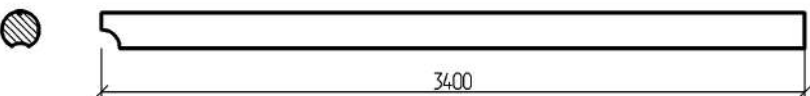
<p>_5_2</p>	<p>6000</p>	<p>1</p>	
<p>_7_1, _8_1, _9_1, _10_1, _11_1, _13_1, _14_1, _15_1, _16_1</p>	<p>2140</p>	<p>9</p>	
<p>_7_2, _8_2, _9_2, _10_2, _11_2, _13_2, _14_2, _15_2, _16_2</p>	<p>2130</p>	<p>9</p>	
<p>_20_1</p>	<p>2000</p>	<p>1</p>	
<p>_20_2</p>	<p>6000</p>	<p>1</p>	
<p>_25_1</p>	<p>2400</p>	<p>1</p>	
<p>_25_2</p>	<p>3400</p>	<p>1</p>	

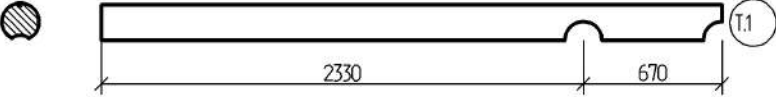
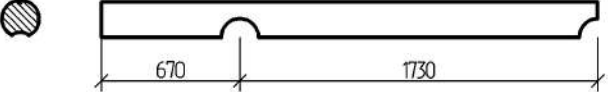
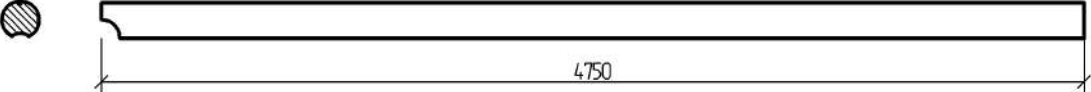
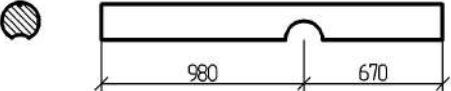
_25_3	3000	1	
_26_1	2400	1	
_26_2	4750	1	
_26_3	1650	1	

180, . . .	:	170,73 . . .	4,34 . . .	58 . . .		27,32 . . .
		0,00 . . .	0,00 . . .	0 . . .		102,91 . . .

. : 180, .			
- (): 31 (): 31,13 (.): 0,79			
_1_1, _8_1, _15_1, _16_1, _17_1, _18_1, _19_1	2270	7	
_2_1, _3_1, _4_1, _5_1, _6_1, _7_1, _9_1, _10_1, _11_1, _12_1, _13_1, _14_1	730	12	
_2_2, _3_2, _4_2, _5_2, _6_2, _7_2, _9_2, _10_2, _11_2, _12_2, _13_2, _14_2	540	12	

180, .	:	31,13 . .	0,79 . .	31 .		4,98 . .
		0,00 . .	0,00 . .	0 .		20,14 . .

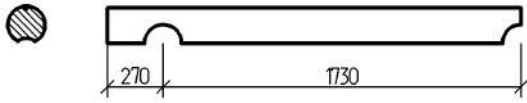
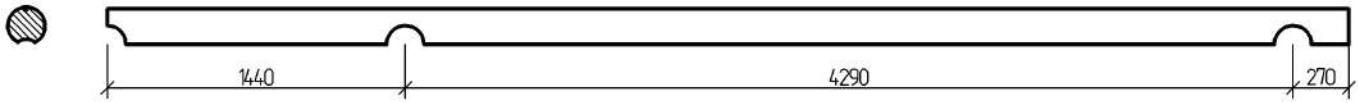
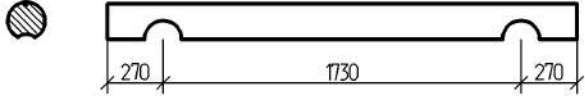
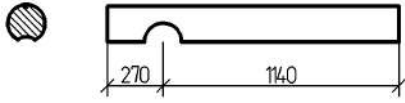
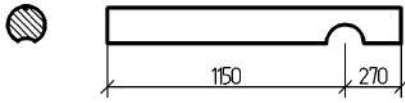
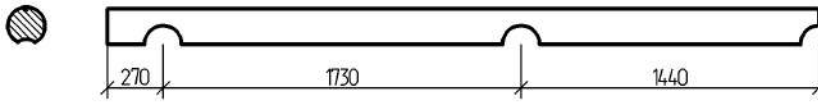

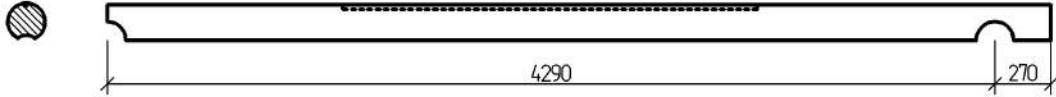
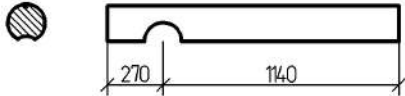
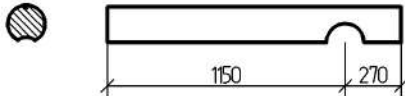
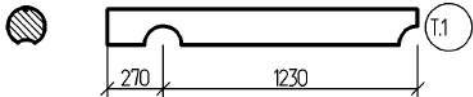
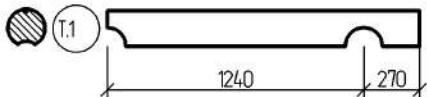
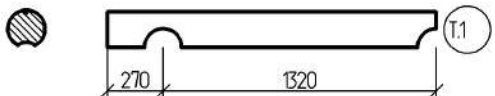
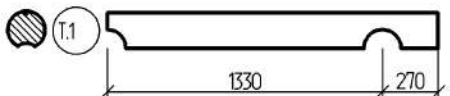
				. : 180, .	
					- (): 50 (): 119,00 (.): 3,03
_1_1, _15_1, _17_1, _19_1	2000	4			
_1_2, _15_2, _17_2, _19_2	6000	4			
_2_1, _3_1, _4_1, _5_1, _6_1, _7_1, _9_1, _10_1, _11_1, _12_1, _13_1, _14_1	2270	12			
_2_2, _3_2, _4_2, _5_2, _6_2, _7_2	1410	6			
_2_3, _3_3, _4_3, _5_3, _6_3, _7_3	1420	6			
_8_1, _16_1, _18_1	3440	3			

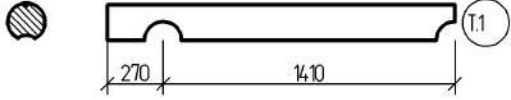
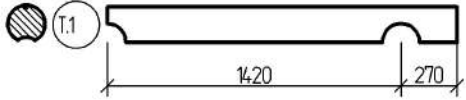
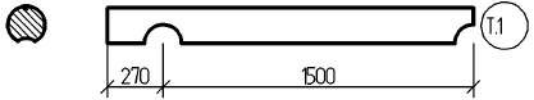
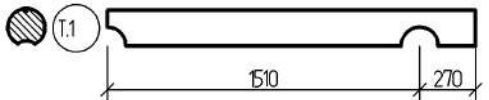
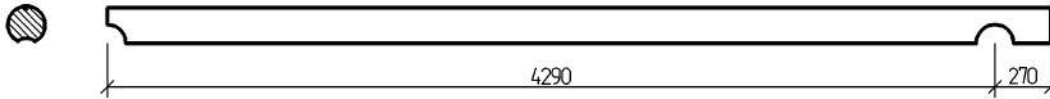
_8_2	4560	1	
_9_2, _10_2	1410	2	
_9_3, _10_3	1420	2	
_11_2	1500	1	
_11_3	1510	1	
_12_2	1590	1	
_12_3	1600	1	



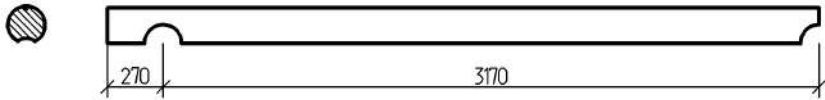
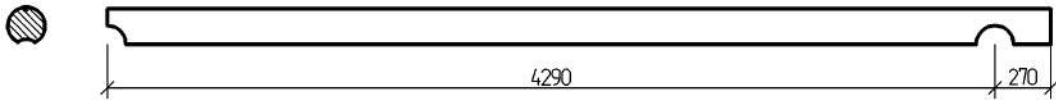
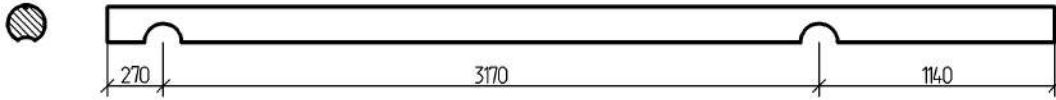
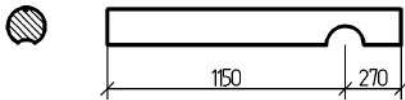
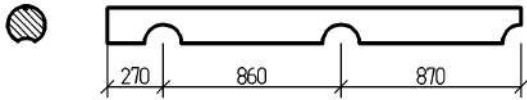
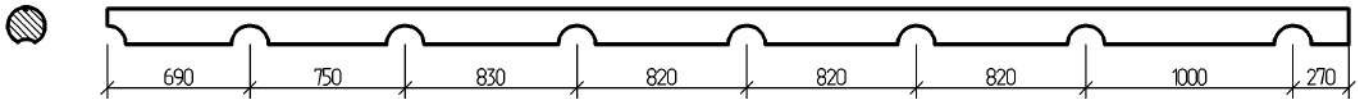

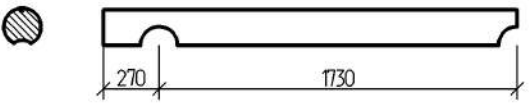
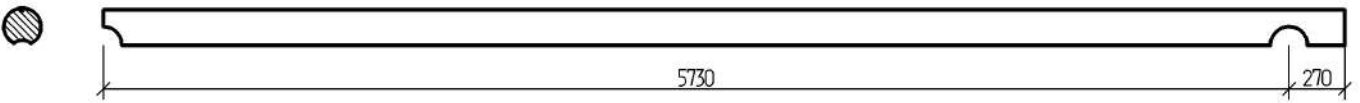
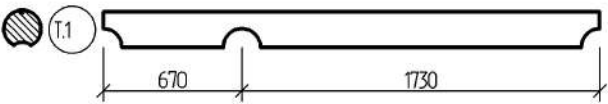
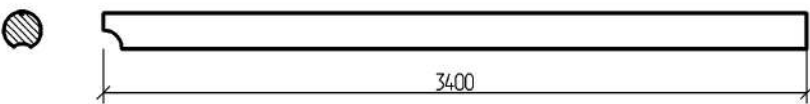
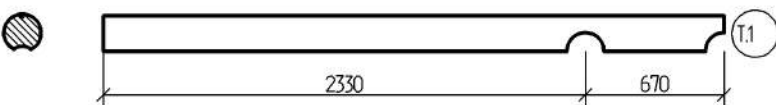
_13_2	1680	1	
_13_3	1690	1	
_14_2	1770	1	
_14_3	1780	1	
_16_2, _18_2	4560	2	

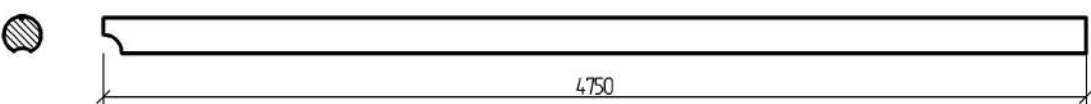
180, . .	:	119,00 . .	3,03 . .	50 .		19,04 . .
		0,00 . .	0,00 . .	0 .		73,28 . .

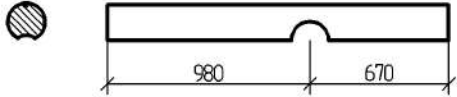
			. : 180, .	- (): 54 (): 191,60 (.): 4,88
_1_1, _2_1, _3_1, _4_1, _5_1, _6_1, _12_1, _17_1, _18_1, _19_1	3440	10		
_1_2, _2_2, _3_2, _4_2, _5_2, _6_2, _12_2, _17_2, _18_2, _19_2	4560	10		
_7_1, _8_1, _9_1, _10_1, _11_1, _13_1, _14_1, _15_1, _16_1	4580	9		
_7_2, _8_2, _9_2, _10_2, _11_2, _13_2, _14_2, _15_2, _16_2	1420	9		
_20_1	2000	1		
_20_2	6000	1		

<p>_21_1, _22_1, _23_1, _24_1</p>	<p>2000</p>	<p>4</p>	
<p>_21_2, _22_2, _23_2, _24_2</p>	<p>6000</p>	<p>4</p>	
<p>_25_1</p>	<p>2400</p>	<p>1</p>	
<p>_25_2</p>	<p>3400</p>	<p>1</p>	
<p>_25_3</p>	<p>3000</p>	<p>1</p>	
<p>_26_1</p>	<p>2400</p>	<p>1</p>	
<p>_26_2</p>	<p>4750</p>	<p>1</p>	

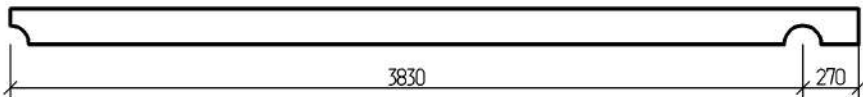
_26_3		1650	1			
180,	:		191,60 . .	4,88 . .	54 .	30,66 . .
	.		0,00 . .	0,00 . .	0 .	114,59 . .

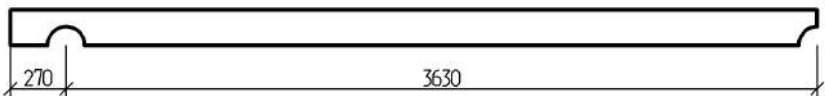
			. : 180, .		- (): 12
					(): 48,00
					(.): 1,22
_1_20_1	3900	1			
_1_20_2, _2_20_2, _3_20_2, _4_20_2, _5_20_2, _6_20_2	4100	6			
_2_20_1, _3_20_1, _4_20_1, _5_20_1, _6_20_1	3900	5			

180,	:	48,00 . . .	1,22 . . .	12 .		
	:	0,00 . . .	0,00 . . .	0 .		27,66 . . .

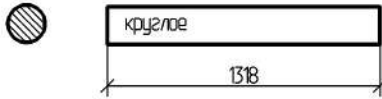
. : 180, . - (): 1 (): 1,32 (.): 0,04						
_1_1	1318	1				
180 :	:	1,32 . .	0,04 . .	1 .		
		0,00 . .	0,00 . .	0 .		0,86 . .
	:	1				

			: 180, , .	- (): 7 (): 26,27 (.): 0,33
_0_1, _0_1	2000	2		
_0_2, _0_2	6000	2		
_0_1	2270	1		
_0_1	3450	1		
_0_2	4550	1		

180,	:	26,27 . . .	0,33 . . .	7 .		
		0,00 . . .	0,00 . . .	0 .		12,33 . . .

:	:	1 256,15 . . .	31,64 . . .	462 .		191,12 . . .
		0,00 . . .	0,00 . . .	0 .		725,81 . . .
	:	1 210,34 . . .	145,24 . . .			0,00 . . .
	:	0 .	:	0,02 .		0
	:	0	:	0	:	0
	:	0	:	0	:	0
	:	645	:	645	:	0
	:	1				